

Varenummer: 3901030010700
 Beskrivelse: Snekkegear med fri indgangsaksel
 VF 30P-10-HS

Mål

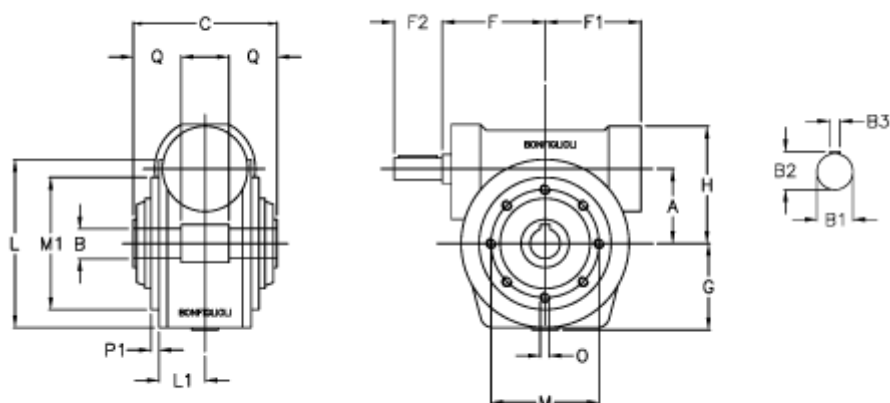

a	= 30.0	F1	= 46	O	= M6x7
B	= 14	F2	= 20	P1	= 1.5
B1	= 9	g	= 41	Q	= 20.5
B2	= 10.2	H	= 50		
B3	= 3	L	= 80.0		
Betegnelse	= VF 30P-xx-HS	L1	= 30.0		
C	= 55	m	= 65		
F	= 50.0	M1	= 50		